

**CAN BE
CUSTOMIZED**

DIGITAL MEASUREMENT STATION

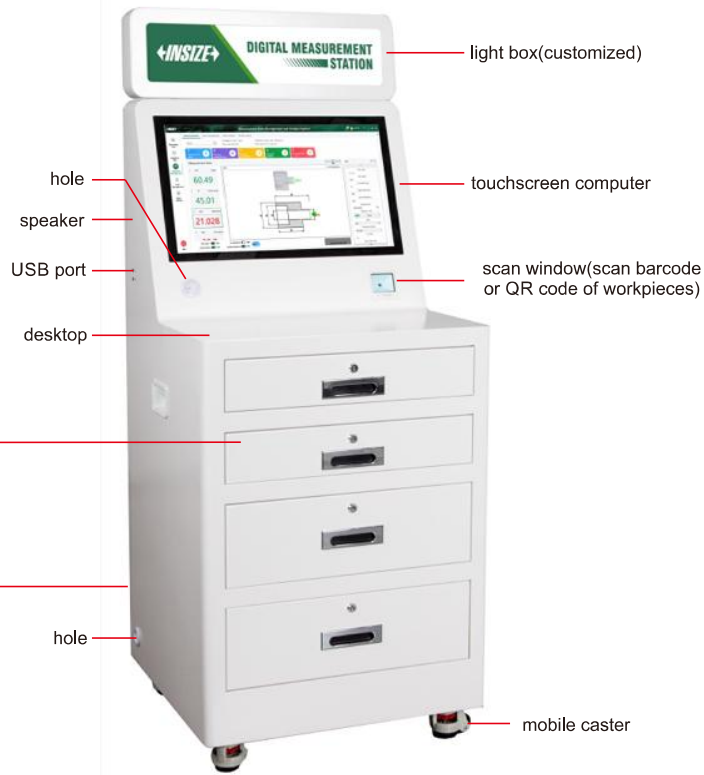
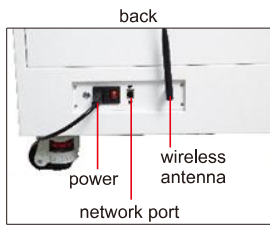
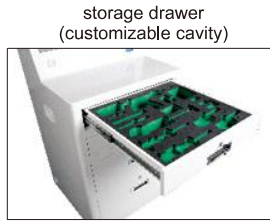

7906-06

- The small and lightweight station is easy to move, and equipped with a 23.6-inch touchscreen computer (i7 CPU&Windows system)

Code	L×W×H
7906-06	650×600×1617mm

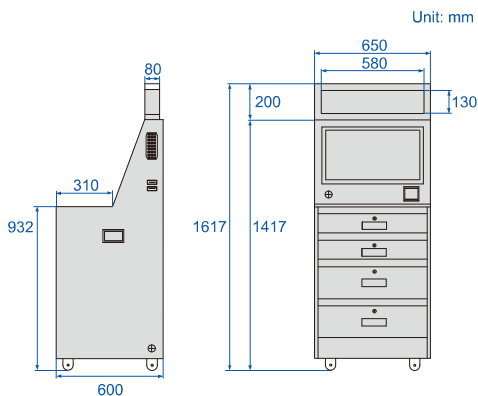















application





















DIGITAL DEMO MEASUREMENT STATION

Code	Includes
7906-06SD	Digital measurement station, digital caliper, micrometer, bore gauge, measuring tape, receiver, software, demo workpiece and measuring tools cavity
7906-06SE	Digital measurement station, digital caliper, micrometer, bore gauge, measuring tape, torque wrench, roughness tester, receiver, software, thickness gauge, hardness tester, demo workpiece and measuring tools cavity

DETAILS

Code	Includes	Description	Specification	Picture
7906-06SD	7906-06	Digital measurement station	1. Dimension(LxWxH): 650×600×1617mm 2. With a computer	
	1108-150+ 7315-25	Digital caliper	1. Range: 0-150mm/0-6" 2. Resolution: 0.01mm/0.0005"	
	1113-150	Built-in wireless digital caliper	1. Range: 0-150mm/0-6" 2. Resolution: 0.01mm/0.0005"	
	3101-25A+ 7315-31+6301	Waterproof digital outside micrometer	1. Range: 0-25mm/0-1" 2. Resolution: 0.001mm/0.00005"	
	3112-25WL+ 6301	Built-in wireless waterproof digital outside micrometer	1. Range: 0-25mm/0-1" 2. Resolution: 0.001mm/0.00005"	
	2122-35A+ 7315-51B	Digital bore gauge	1. Range: 18-35mm/0.7-1.3" 2. Resolution: 0.002mm/0.0001" or switch to 0.01mm/0.0005"	
	2124-25+ 2508-10FWL	Built-in wireless pistol grip three points bore gauge	1. Range: 20-25mm/0.78-1" 2. Resolution: 0.001mm/0.00005"	
	9570-A5	Built-in wireless digital measuring tape	1. Range: 5m 2. Resolution: 0.001m	
	7315-2	multichannel receiver	1. Text format, virtual com port 2. USB port 3. Connected with 16 transmitter	
	7315-6	multichannel receiver	1. Keyboard signal 2. USB port 3. Connected with 6 transmitter	
	7315-7	multichannel receiver	1. Keyboard signal 2. Type-C port 3. Connected with 6 transmitter	
	7349	Measurement data management and analysis software	1. Include: measuring tools management, make inspection plan, data acquisition, data management, SPC analysis, quality report	
	5017-WP	Demo workpiece	1. Aluminum workpiece 2. With workpiece inspection drawing and inspection values	
7319-DE3	Demo workpiece	1. Aluminum workpiece 2. With workpiece inspection drawing and inspection values		

Code	Includes	Description	Specification	Picture
7906-06SE	7906-06	Digital measurement station	1. Dimension(LxWxH): 650×600×1617mm 2. With a computer	
	1108-150+ 7315-25	Digital caliper	1. Range: 0-150mm/0-6" 2. Resolution: 0.01mm/0.0005"	
	1113-150	Built-in wireless digital caliper	1. Range: 0-150mm/0-6" 2. Resolution: 0.01mm/0.0005"	
	3101-25A+ 7315-31+6301	Waterproof digital outside micrometer	1. Range: 0-25mm/0-1" 2. Resolution: 0.001mm/0.00005"	
	3112-25WL+ 6301	Built-in wireless waterproof digital outside micrometer	1. Range: 0-25mm/0-1" 2. Resolution: 0.001mm/0.00005"	
	2122-35A+ 7315-51B	Digital bore gauge	1. Range: 18-35mm/0.7-1.3" 2. Resolution: 0.002mm/0.0001" or switch to 0.01mm/0.0005"	
	2124-25+ 2508-10FWL	Built-in wireless pistol grip three points bore gauge	1. Range: 20-25mm/0.78-1" 2. Resolution: 0.001mm/0.00005"	
	9570-A5	Built-in wireless digital measuring tape	1. Range: 5m 2. Resolution: 0.001m	
	IST-42W20A	Built-in wireless digital torque wrench	1. Range: 4-20N.m 2. Resolution (Ra): 0.01N.m	
	ISR-C300WL	Built-in wireless roughness tester	1. Range: X axis:17.5mm, Z axis: 320μm (-160μm~160μm) 2. Resolution (Ra): 0.001μm	
	9501-1200WL	Built-in wireless coating thickness gauge	1. Range: 0-1250μm 2. Resolution: 0.1μm (range<100μm), 1μm (range≥100μm)	
	ISU-800DWL	Built-in wireless ultrasonic thickness gauge	1. Range: I-E 0.9-28mm/E-E 0.15-14mm 2. Resolution: 0.01mm/0.001mm	
	HDT-LP200WL	Built-in wireless Portable Ieeb hardness tester	1. Range: HL170-960/HRC 17-70/HRB 13-109/HRA 7-89/ HB 20-655/HV 80-940/HSD 32-99.5/σb(rm) 255-2639N/mm ² 2. Resolution: 1HLD/1HV/1HB/0.1HRC/0.1HRB/0.1HRA/ 0.1HSD/1σb	
	7315-2	multichannel receiver	1. Text format, virtual com port 2. USB port 3. Connected with 16 transmitter	
7315-6	multichannel receiver	1. Keyboard signal 2. USB port 3. Connected with 6 transmitter		
7315-7	multichannel receiver	1. Keyboard signal 2. Type-C port 3. Connected with 6 transmitter		

Code	Includes	Description	Specification	Picture
7906-06SE	7349	Measurement data management and analysis software	1. Include: measuring tools management, make inspection plan, data acquisition, data management, SPC analysis, quality report	
	5017-WP	Demo workpiece	1. Aluminum workpiece 2. With workpiece inspection drawing and inspection values	
	7319-DE3	Demo workpiece	1. Aluminum workpiece 2. With workpiece inspection drawing and inspection values	